

Eclipse Series, 304 Stainless Steel - NEMA 4X

Single Window Door Enclosures



Panel Sold Separately



Corrosion Resistant

Wallmount Enclosures

Application

- Designed to enclose electrical and/or electronic equipment in wallmount applications where viewing of component operation is necessary while maintaining protection ratings.
- Impressive styling features like hidden hinges and attractive latching systems make the Eclipse a suitable addition to any high-tech equipment installation.
- A wide range of sizes and practical accessories make this product line a complete package.
- For high temperature applications, a gasket retainer may be required, please refer to factory.

Standards

- UL 508 Type 3R, 4, 4X and 12
- CSA Type 3R, 4, 4X and 12
- **Complies with**
 - NEMA Type 3R, 4, 4X, 12 and 13
 - IEC 60529, IP66

Construction

- Formed 14 or 16 gauge 304 stainless steel.
- Full view UV resistant polycarbonate window allows maximum viewing area of inner panel.
- Continuously welded seams ground smooth.
- Door stiffeners are provided where required for increased strength and rigidity - designed to also permit additional mounting options.
- Formed lip on enclosure to exclude flowing liquids and contaminants.
- Door latches feature the added safety of quarter turn slot requiring use of tool for opening.
- Doors may be easily removed for modifications and are interchangeable.
- Oil resistant gaskets are permanently secured.
- Collar studs provided for mounting inner panel.
- Includes hardware kit with panel mounting nuts and sealing washers for wall mounting holes.
- Bonding stud provided on door and grounding stud installed in enclosure.
- Hinges are constructed from 304 stainless steel.
- Stainless steel hinge pins and quarter turns.

Finish

- Cover and enclosure are natural stainless steel with a smooth brushed finish.

Accessories

- Air conditioners...see page **387-406**
- Blowers...see page **407**
- Breather kits...see page **423**
- DIN rails...see page **80**
- DIN rail mounting kit...see page **79**
- Door stop kit...see page **447**
- Filter fans...see page **408-414**
- Heaters...see page **418-420**
- Handles...see page **81**
- Inner panel...see page **78**
- Quarter turn inserts and keys...see page **80**
- Literature pocket...see page **451**
- Mounting foot kit...see page **81**
- Swing frame...see page **79**
- Swing panel...see page **78**
- Replacement hinge pins...see page **79**
- Replacement quarter turn assemblies...see page **80**
- Thermostats...see page **421-422**
- UL/CSA approved hardware kit...see page **430**
- Padlock Adaptor (EPA)...see page **81**

Eclipse Series, 304 Stainless Steel - NEMA 4X

Single Window Door Enclosures

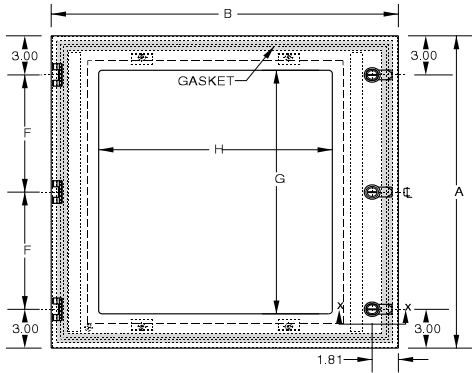

Front View

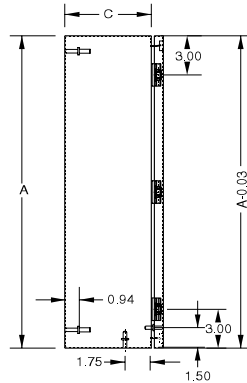

Side View
Hinge Side

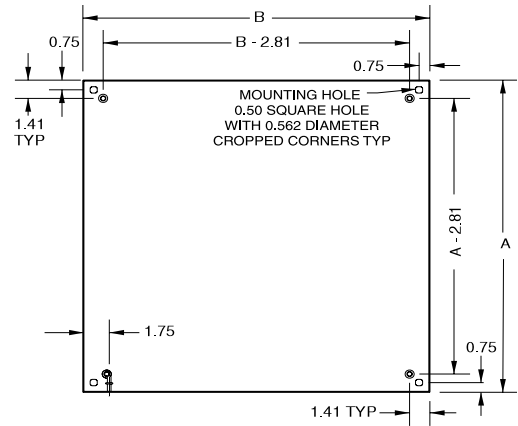

Front Section
Door & Body Flange Removed

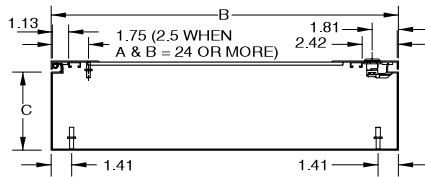

Bottom View

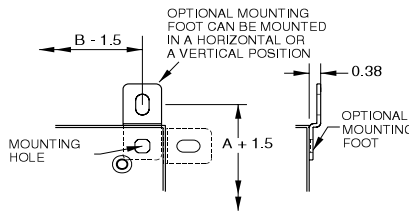

Mounting Detail
Door & Body Flange Removed

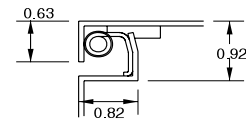

Cross Section of 14 gauge Body & Door

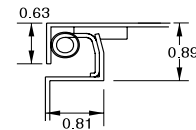

Cross Section of 16 gauge Body & Door

Part No.	Overall Dimensions			Door/ Body Gauge	Latch ¹ Qty	Hinge Qty	F	Viewing Area			Optional Panel Part No.	Inner Panel Dimensions		Ship Wt. Lbs.
	A	B	C					G	H	D		E		
EN4SD16126WSS	16	12	6	16	1	2	10	11.33	6.71	EP1612	14.2	10.2	16	
EN4SD20166WSS	20	16	6	16	1	2	14	15.33	10.71	EP2016	18.2	14.2	22	
EN4SD20206WSS	20	20	6	16	1	2	14	15.33	14.71	EP2020	18.2	18.2	26	
EN4SD20168WSS	20	16	8	16	1	2	14	15.33	10.71	EP2016	18.2	14.2	25	
EN4SD20208WSS	20	20	8	16	1	2	14	15.33	14.71	EP2020	18.2	18.2	28	
EN4SD24208WSS	24	20	8	16	1	2	18	19.33	14.71	EP2420	22.2	18.2	32	
EN4SD24248WSS	24	24	8	14	2	2	18	18.33	16.15	EP2424	22.2	22.2	40	
EN4SD30248WSS	30	24	8	14	2	3	12	24.33	16.15	EP3024	28.2	22.2	46	

¹ All Window Door latch types are quarter turns.

Corrosion Resistant Wallmount Enclosures